

# Analog Devices Welcomes Hittite Microwave Corporation

NO CONTENT ON THE ATTACHED DOCUMENT HAS CHANGED



**THIS PAGE INTENTIONALLY LEFT BLANK**

**SUCCESSIVE DETECTION LOG VIDEO  
AMPLIFIER (SDLVA), 1 - 20 GHz**

**Not Recommended for New Designs**



**Features**

- 1 to 20 GHz Operation
- High Logging Range: 59 dB
- Output Frequency Flatness:  $\pm 2$  dB
- Internal Voltage Regulation
- Fast Rise/Fall Times: 2/7 ns
- Hermetically Sealed Module
- Single Positive Supply: +7V to +16V
- 55 °C to +85 °C Operating Temperature

**Typical Applications**

- The HMC-C052 is ideal for:
- EW, ELINT & IFM Receivers
  - DF Radar Systems
  - ECM Systems
  - Broadband Test & Measurement
  - Power Measurement & Control Circuits
  - Military & Space Applications

**Functional Diagram**

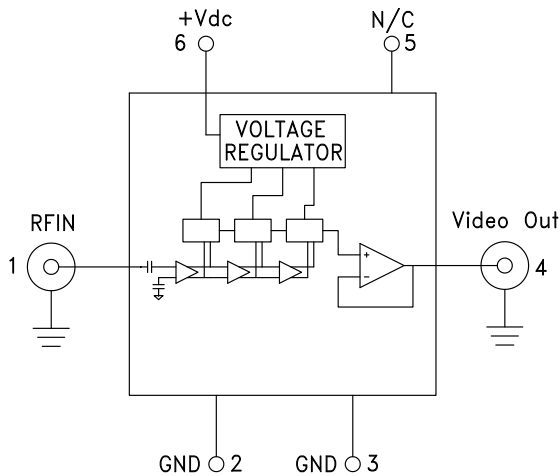

**General Description**

The HMC-C052 is a Successive Detection Log Video Amplifier (SDLVA) which operates from 1 to 20 GHz. The HMC-C052 provides a logging range of 59 dB.

This product comes standard with two female SMA field replaceable connectors but can also be used with blind mate SMP connectors or as a drop-in module. The package size measures 1.086 x 0.85 x 0.23" (27.58 x 21.6 x 5.84 mm) making it ideal for environmentally robust applications where space is limited.

The HMC-C052 has an integrated voltage regulator that allows the SDLVA to operate from a single supply between +7 and +16V without any appreciable change in performance.

**Electrical Specifications,  $T_A = +25$  °C  $V_{dc} = +12V$**

Parameter	Conditions	Typ.	Units
Input Frequency Range		1 - 20	GHz
Frequency Flatness	Pin= -30 dBm	$\pm 2$	dB
Log Linearity	Pin= -50 dBm to +0 dBm	$\pm 1$	dBm
Log Linearity over Temperature	-55 to +85° C, Pin= -30 dBm	$\pm 1$	dB
Minimum Logging Range	to $\pm 3$ dB error	-54	dBm
Maximum Logging Range	to $\pm 3$ dB error	+5	dBm
Input Return Loss		9	dB
Log Video Minimum Output Voltage		0.9	V

**SUCCESSIVE DETECTION LOG VIDEO  
AMPLIFIER (SDLVA), 1 - 20 GHz**

**Not Recommended for New Designs**

**Electrical Specifications, (continued)**

Parameter	Conditions	Typ.	Units
Log Video Maximum Output Voltage		1.5	V
Log Video Output Rise Time	Pin = -20 dBm, 10% to 90%	2	ns
Log Video Output Fall Time	Pin = -20 dBm, 90% to 10%	7	ns
Vdc Voltage Range	7 - 16	12	V
Log Video Recovery Time	-50 dBm to 0 dBm	21	ns
Log Video Output Slope		14	mV/dB
Log Video Output Slope Variation over Temperature	@ 10 GHz	5	μV/dB°C
Log Video Propagation Delay		3	ns
Supply Current (Idc)		86	mA

**Error Flatness vs.  
Input Power Over Frequency**

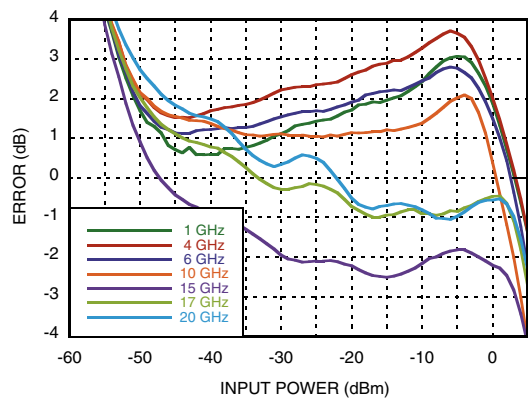

**X-Band Error Flatness vs.  
Input Power Over Frequency**

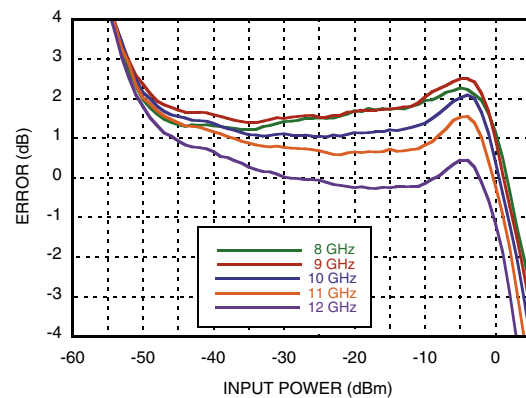

**VIDEO OUT & Error  
vs. Input Power, Fin= 1 GHz**

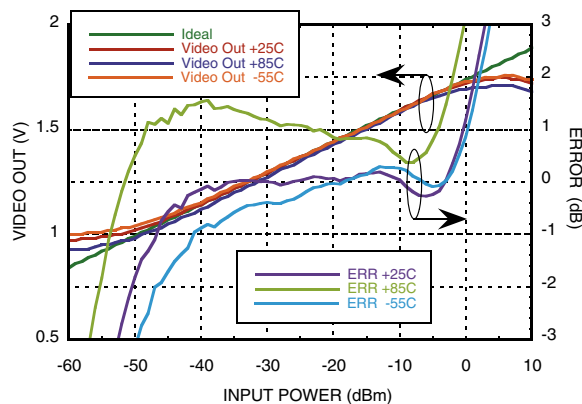

**VIDEO OUT & Error  
vs. Input Power, Fin= 4 GHz**

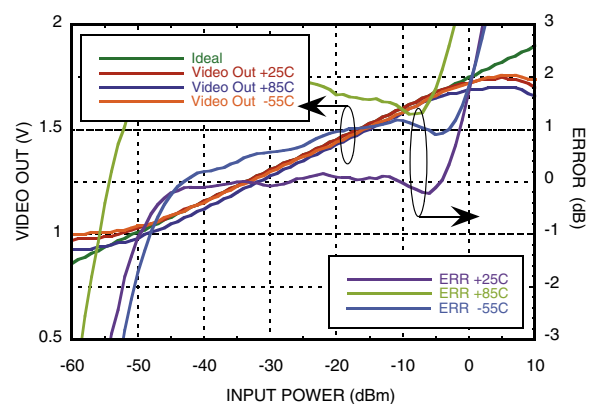

**SUCCESSIVE DETECTION LOG VIDEO AMPLIFIER (SDLVA), 1 - 20 GHz**

**Not Recommended for New Designs**

**VIDEO OUT & Error vs. Input Power,  $F_{in}$  = 6 GHz**

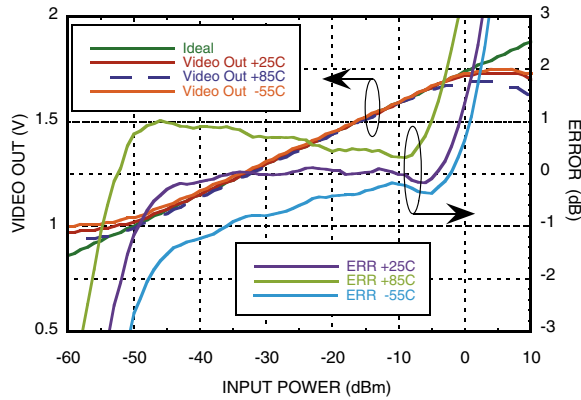

**VIDEO OUT & Error vs. Input Power,  $F_{in}$  = 10 GHz**

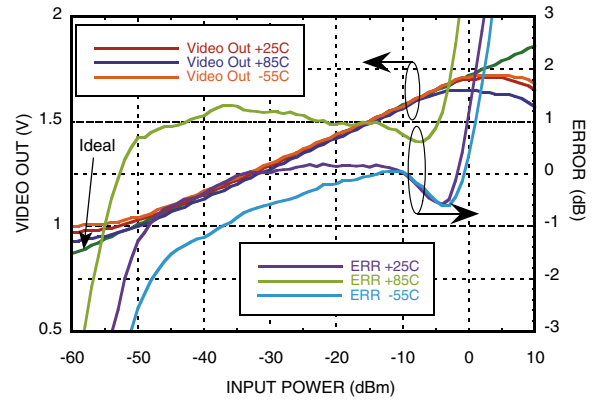

**VIDEO OUT vs. Error vs. Input Power,  $F_{in}$  = 12 GHz**

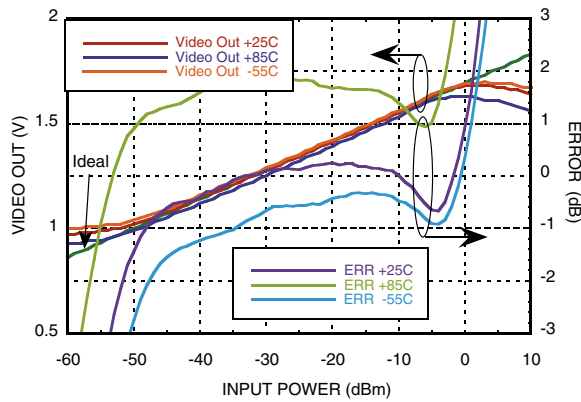

**VIDEO OUT & Error vs. Input Power,  $F_{in}$  = 15 GHz**

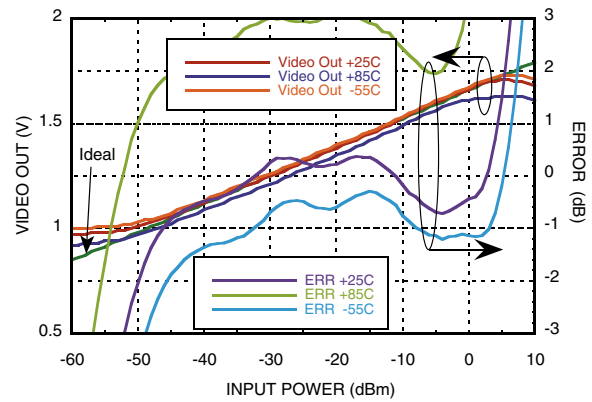

**VIDEO OUT & Error vs. Input Power,  $F_{in}$  = 17 GHz**

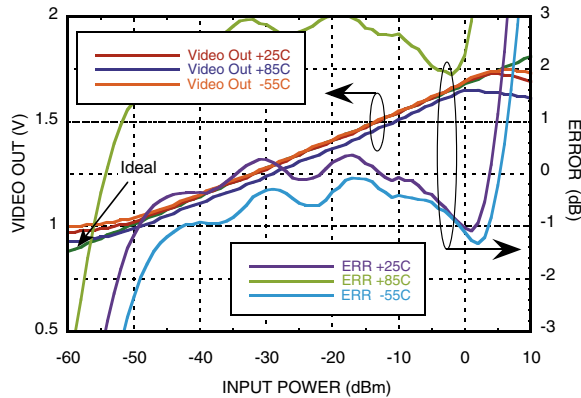

**VIDEO OUT & Error vs. Input Power,  $F_{in}$  = 20 GHz**

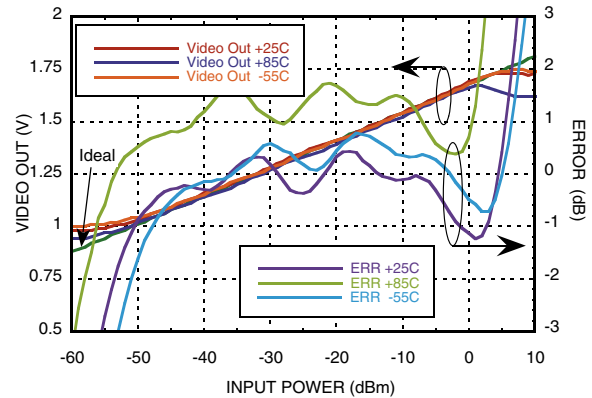

SDLVAS - SMT

**SUCCESSIVE DETECTION LOG VIDEO  
AMPLIFIER (SDLVA), 1 - 20 GHz**

**Not Recommended for New Designs**

**VIDEO OUT vs. Frequency  
Over Input Power & Temperature**

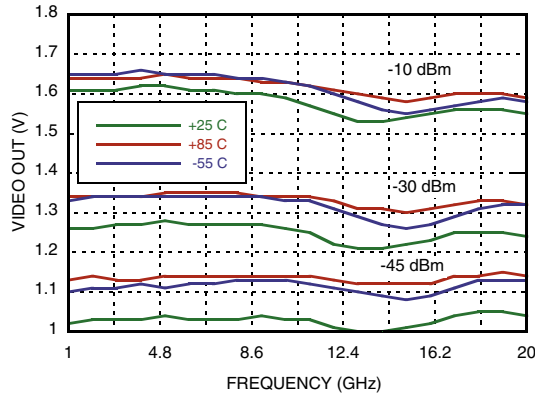

**Input Return Loss vs. Frequency**

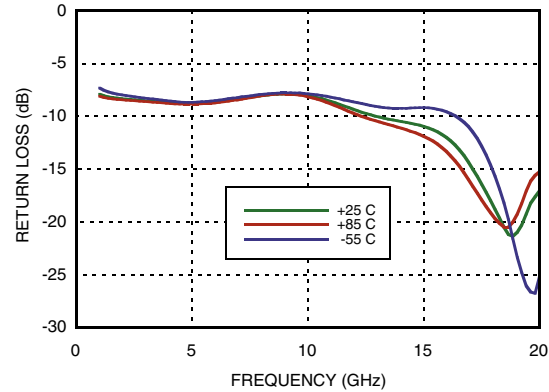

**Rise Time @ 10 GHz @ -20 dBm**

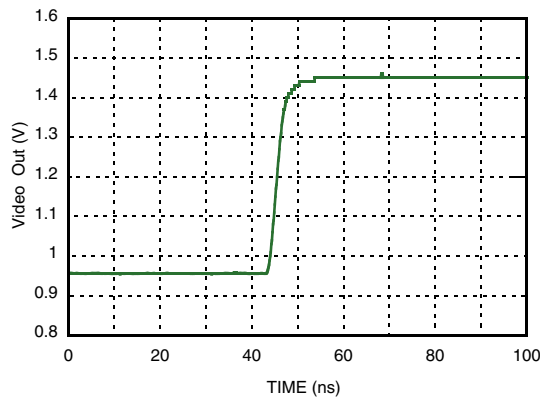

**Fall Time @ 10 GHz @ -20 dBm**

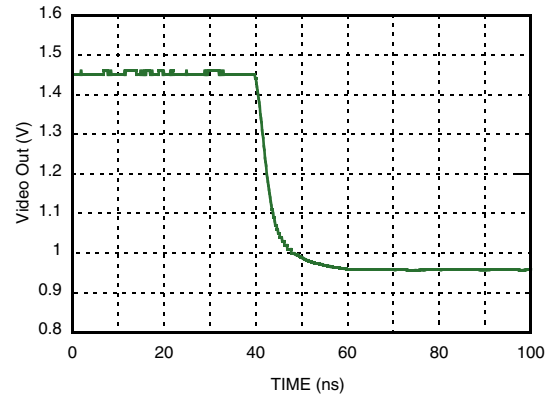

**Absolute Maximum Ratings**

I <sub>cc</sub>	100 mA
Input Signal Amplitude	18 dBm
Junction Temperature	125 °C
Continuous P <sub>diss</sub> (T=85°C) Derate 59 mW/°C above 85°C	1.6 W
Thermal Resistance (R <sub>th</sub> ) (junction to package bottom)	17 °C/W
V <sub>dc</sub> Max	+16V
Storage Temperature	-65 to +150 °C
Operating Temperature	-55 to +85 °C
ESD Sensitivity (HBM)	Class 0 (<250V)



**ELECTROSTATIC SENSITIVE DEVICE  
OBSERVE HANDLING PRECAUTIONS**

**SUCCESSIVE DETECTION LOG VIDEO  
AMPLIFIER (SDLVA), 1 - 20 GHz**

**Not Recommended for New Designs**

**Outline Drawing**

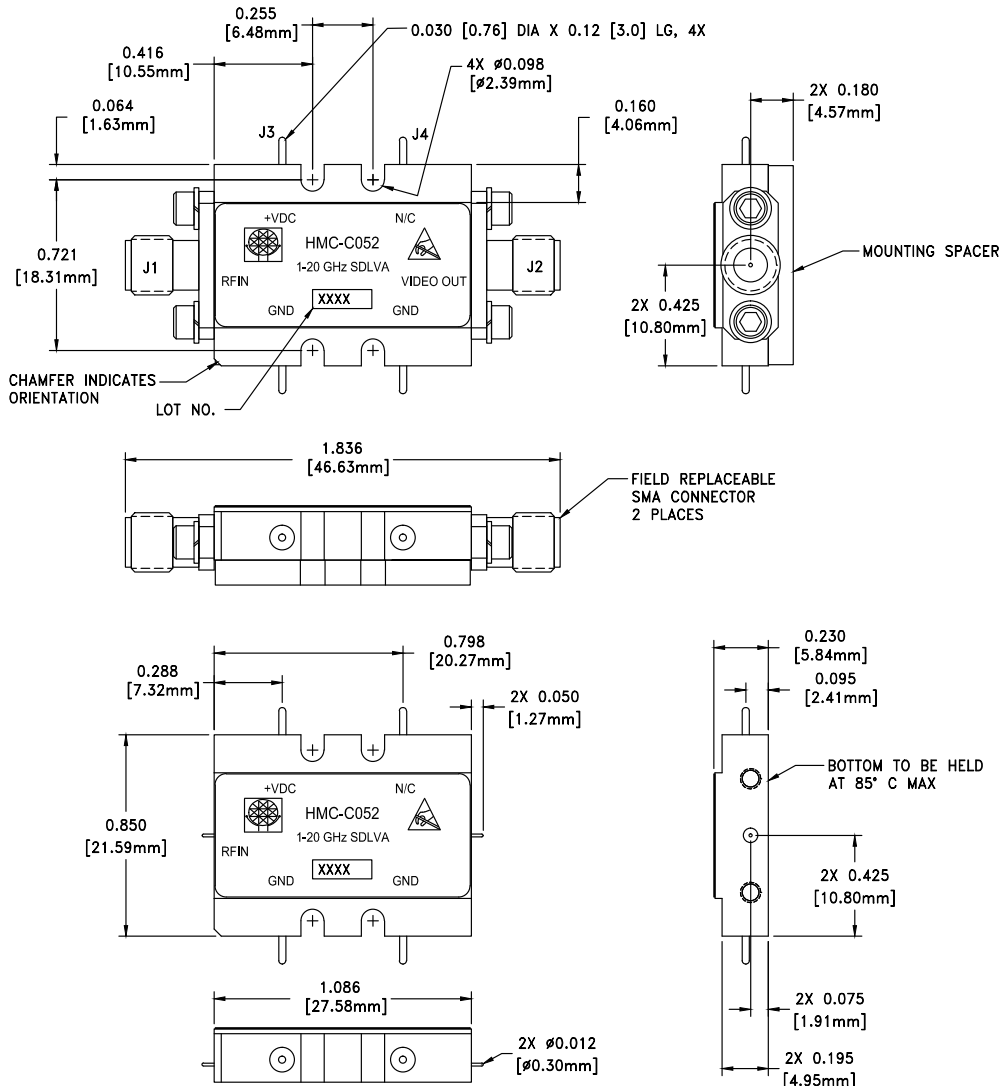

VIEW SHOWN WITH CONNECTORS AND MOUNTING SPACER REMOVED

**Package Information**

Package Type	C-10
Package Weight [1]	16.7 gms [2]
Spacer Weight	3.3 gms [2]

[1] Includes the connectors

[2] ±1 gms Tolerance



**NOTES:**

1. PACKAGE, LEADS, COVER MATERIAL: KOVAR™
2. FINISH: GOLD PLATE OVER NICKEL PLATE
3. ALL DIMENSIONS ARE IN INCHES [MILLIMETERS]
4. TOLERANCES:
  - 4.1 .XX = ±0.02
  - 4.2 .XXX = ±0.010
5. FIELD REPLACEABLE 2.92mm CONNECTORS TENSOLITE 231CCSF OR EQUIVALENT

**SUCCESSIVE DETECTION LOG VIDEO  
AMPLIFIER (SDLVA), 1 - 20 GHz**

**Not Recommended for New Designs**

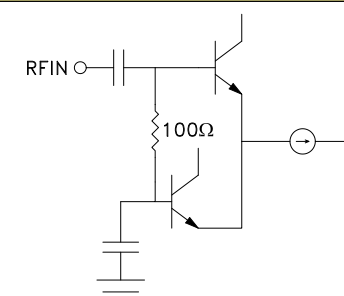
**Pin Descriptions**

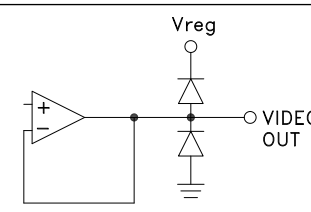
Pin Number	Function	Description	Interface Schematic
1	RFIN	RF Input pin.	
2, 3	GND	These pins must be connected to a high quality RF/DC ground.	
4	VIDEO OUT	Video Out is a voltage that is proportional to the log of the Input Power.	
5	N/C	The pins are not connected internally; however, all data shown herein was measured with these pins connected to RF/DC ground externally.	
6	Vdc	Bias Supply pin.	